

VIPAC Array Family of DC-DC Converters Up to 750 Watts

Description & Installation Guide

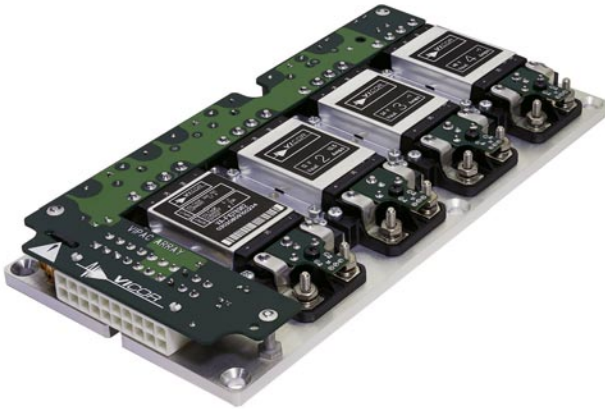

Product Description

The **VIPAC Array** is a highly flexible system of DC input, power building-blocks that can be configured with as many as four user-definable outputs on a low profile, coldplate chassis. VIPAC Array offers the convenience of a prepackaged, chassis mount solution with the performance and power density of Vicor's Maxi, Mini, Micro, DC-DC converters.

Using Vicor's PowerBench design tools, designers are able to quickly specify VIPAC Arrays with standard inputs of 24, 28, 48, 72, 110, 150, 300 or 375 Vdc and standard outputs from 2 to 48 Vdc at power levels up to 600 Watts per output. A total of 8 standard chassis configurations offers the user a choice of power and mechanical options to fit any budget or design. Short cycle time and rapid delivery make VIPAC Array a valuable tool for power system prototyping and development efforts as well.

Product Overview

VIPAC Arrays are ideal for use in distributed and modular power systems where power density and reliable operation are critical. A current share option is available on single module configurations enabling Arrays of identical output voltage and current ratings to be used in applications requiring either redundant operation or kilowatts of power. The 300 and 375 Vdc input versions can be coupled to a bulk AC Front-end to create a modular, scalable power supply serving a variety of power architectures from centralized to distributed. VIPAC Arrays include internal fusing, a global enable/disable function and connectorized input and output terminations to speed system installation while a versatile coldplate chassis simplifies thermal management and mounting.

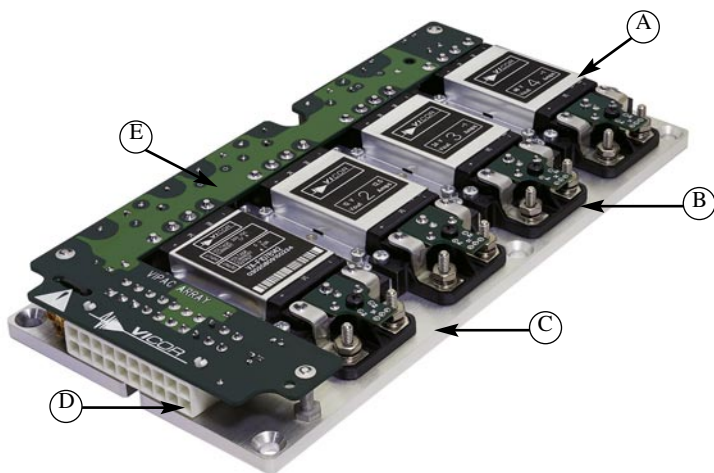

- (A) Vicor's Maxi, Mini, Micro DC-DC Converters**
 Output Voltages 0.5 – 48 Vdc
 50 – 600 W / Output
 (1/4 Brick Modules Shown)
- (B) Choice of Output Termination**
 LugMate
 PlugMate
- (C) Low Profile Coldplate**
 Wide Operating Temperature Range
 Up to 95°C Chassis
 Up to 65°C Ambient
- (D) Standard Input Voltage Ranges**
 10 – 36 Vdc* (VA-D only)
 18 – 36 Vdc*
 36 – 75 Vdc*
 43 – 110 Vdc*
 66 – 154 Vdc*
 100 – 200 Vdc*
 180 – 375 Vdc
 250 – 425 Vdc
 See pp. 4 – 7 for input connections.
- (E) Features**
 Optional current share (see overview)
 Onboard fusing
 Global enable/disable

* Note: 24, 28, 48, 72, 110, & 150 V input VIPAC Arrays are designed primarily for military COTS and industrial applications and do not carry safety agency approvals.

Application Tips

Remote Sense

A remote sense feature is provided on outputs configured with Mini or Maxi sized DC-DC converters. The output sense connections must be terminated either locally or remotely and should not be left open. VIPAC Arrays provided with the optional LugMate connectors are configured for local sensing via removable jumpers installed at the factory. The jumpers will need to be removed if access to the secondary control function is made via mating connector 16385 and connections will need to be established for local or remote sensing.

Wire Routing

Avoid routing wires over the VIPAC Array Power System.
Do not bundle Input and Output leads together.

Parallel Outputs

The VIPAC Array can be configured with parallel modules for increased power or redundancy. When output terminations other than the LugMate are specified the user must properly connect the output and sense terminals. **At no time operate a paralleled output with a load applied to only one module! (See Output Connections)**

Input /Output Connections

J1 Input Connector (View looking into J1)

1										10
11										20

Pin #	Function
1-4	-Vin
5-7	+Vin
8	NC /PR bus
9	PE protective earth
10	- Remote enable
11-13	-Vin
14-17	+Vin
18	NC /PR bus
19	PE protective earth
20	+ Remote enable

VA-J & VA-K configurations only
(300 & 375 Vin single Maxi & single Mini)

Pin #	Function
1-3	-Vin
4-6	+Vin
7	NC
8	NC /PR bus
9	PE protective earth
10	- Remote enable
11-13	-Vin
14-16	+Vin
17	NC
18	NC /PR bus
19	PE protective earth
20	+ Remote enable

To disable output(s)
apply +5 Vdc
between pins
10 and 20 in the
polarity indicated

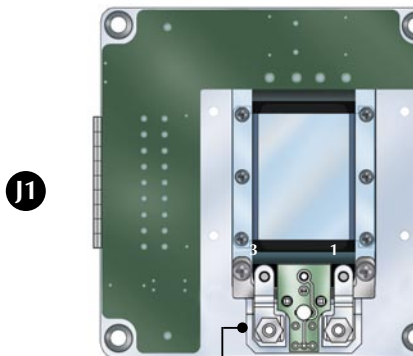

#4-40 torque 4 in. lbs.



Discrete Output

J1 Mating Connector

	Vicor part #	Amp part #
Housing	24795	2-794657-0
Contacts	24796	1-106529-2
Kit	24828	

NOTE: Contacts accept #22-#18 Gage Wire.

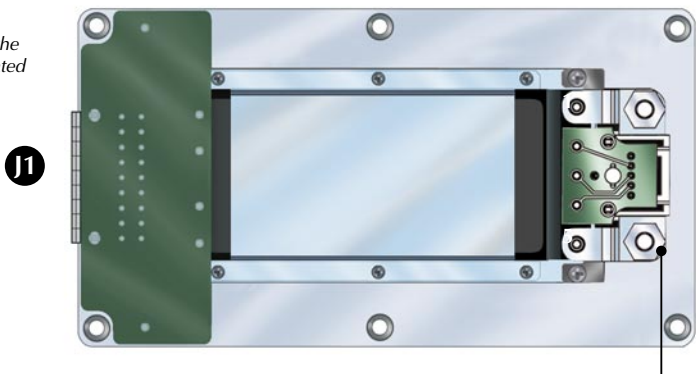

Input /Output Connections

Factory Installed Micro LugMate

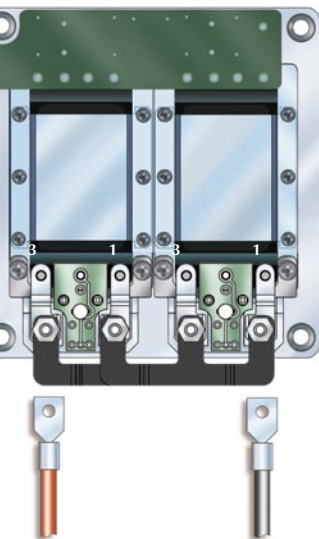

Parallel Output

Shown with the output(s) of two modules connected in parallel using factory installed bus bar.

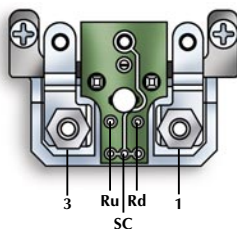

Pin #	Solder Pad	Function
1		-Vout
	Rd	Trim Down
	SC	Secondary Control
	Ru	Trim Up
3		+Vout

Consult design calculator for Rd/Ru trim resistor values located at vicorpower.com.

Factory Installed Mini/Maxi LugMate

Pin #	Conn. Function	Mating Conn.
1	-Vout	
J4-1	-Vout	P/N 16385 *Removable Jumper
J4-2	-Sense	
J4-3	Secondary Control	
J4-4	+Sense	
J4-5	+Vout	
5	+Vout	

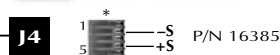

*Removable jumpers in J4 are factory installed for local sensing. For remote sensing the +Sense pins should be tied to the same point on the +Out power bus; the -Sense pins should be tied to the same point the -Out power bus.

J1 Input Connector (View looking into J1)

1										10
11										20

Pin #	Function
1-4	-Vin
5-7	+Vin
8	NC /PR bus
9	PE protective earth
10	- Remote enable
11-13	-Vin
14-17	+Vin
18	NC /PR bus
19	PE protective earth
20	+ Remote enable

VA-J & VA-K configurations only
(300 & 375 Vin single Maxi & single Mini)

Pin #	Function
1-3	-Vin
4-6	+Vin
7	NC
8	NC /PR bus
9	PE protective earth
10	- Remote enable
11-13	-Vin
14-16	+Vin
17	NC
18	NC /PR bus
19	PE protective earth
20	+ Remote enable

To disable output(s) apply +5 Vdc between pins 10 and 20 in the polarity indicated

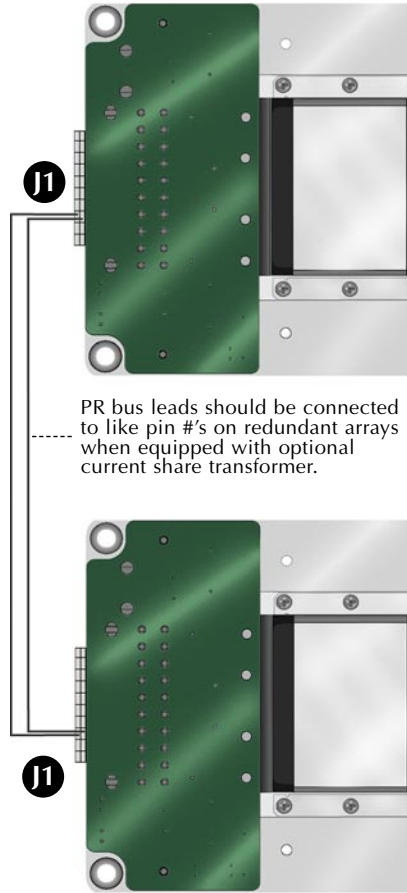

J1 Mating Connector

	Vicor part #	Amp part #
Housing	24795	2-794657-0
Contacts	24796	1-106529-2
Kit	24828	

Parallel/Redundant Connections

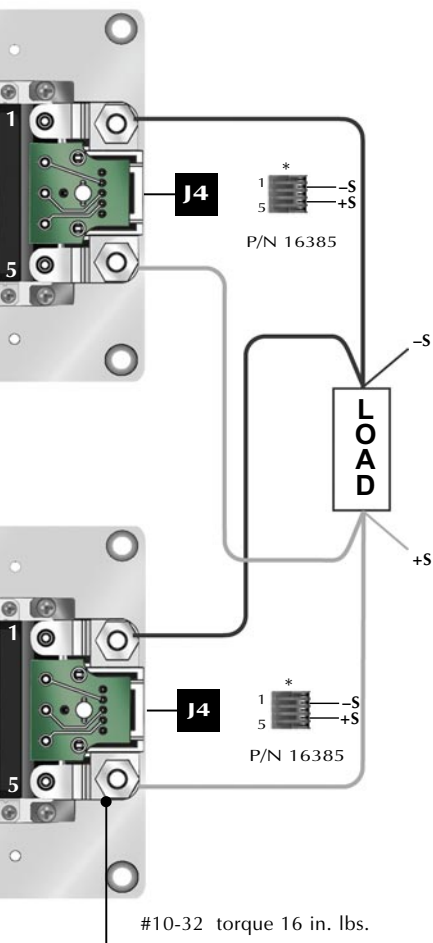

Factory Installed Mini/Maxi LugMate

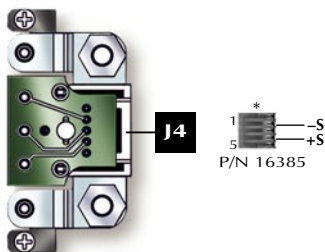

Pin #	Conn.	Function	Mating Conn.
1		- Vout	
	J4-1	- Vout	P/N 16385
	J4-2	- Sense	
	J4-3	Secondary Control	
	J4-4	+ Sense	
	J4-5	+ Vout	
5		+ Vout	

*Removable jumpers in J4 are factory installed for local sensing. For remote sensing the +Sense pins should be tied to the same point on the +Out power bus; the -Sense pins should be tied to the same point the -Out power bus.

** There should be one master module, this is realized by choosing one module to be the master and shorting the SC to -S on the other module. Units configured from the factory as paralld will already have this configured.

PlugMate Output Connectors

PlugMate

(Factory Installed Option)

Micro PlugMate

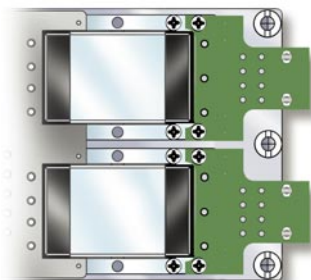

Vicor P/N 25073

1		4
5		8



Pin #	Function	Pin #	Function
1	+Vout	5	+Vout
2	+Vout	6	N/C
3	-Vout	7	SC
4	-Vout	8	-Vout

Mating Connector	Amp. P/N	Vicor P/N
Housing	TYC-794657-8	25056
Pin	1-106529-2	24796
Kit		25073

1						9
10						18

Mini PlugMate

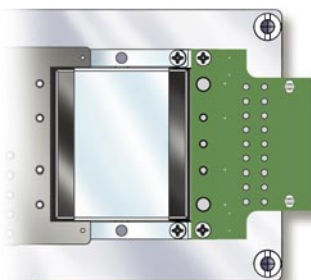

Vicor P/N 25067



Pin #	Function	Pin #	Function
1	+Vout	10	+Vout
2	+Vout	11	+Vout
3	+Vout	12	+Vout
4	N/C	13	+S
5	N/C	14	SC
6	N/C	15	-S
7	-Vout	16	-Vout
8	-Vout	17	-Vout
9	-Vout	18	-Vout

Mating Connector	Amp. P/N	Vicor P/N
Housing	TYC1-794657-8	25050
Pin	1-106529-2	24796
Kit		25067

1												12
13												24

Maxi PlugMate

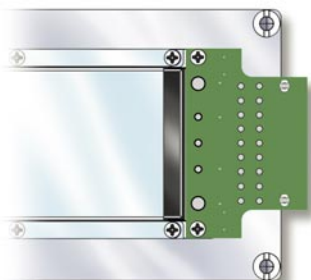

Vicor P/N 25061



Pin #	Function	Pin #	Function
1	+Vout	13	+Vout
2	+Vout	14	+Vout
3	+Vout	15	+Vout
4	+Vout	16	+Vout
5	+Vout	17	+Vout
6	N/C	18	+S
7	SC	19	-S
8	-Vout	20	-Vout
9	-Vout	21	-Vout
10	-Vout	22	-Vout
11	-Vout	23	-Vout
12	-Vout	24	-Vout

Mating Connector	Amp. P/N	Vicor P/N
Housing	TYC2-794657-4	25044
Pin	1-106529-2	24796
Kit		25061

Please Note:

VIPACs that contain multiple modules configured as a single output (paralleled for power or redundancy) MUST have their Outputs and Sense connected to each other at the load.

DO NOT OPERATE A PARALLEL CONFIGURATION WITH ONLY ONE MODULE CONNECTED.

Additionally one module must be designated as "Master" by having all other modules configured as "Boosters". Boosters are created by shorting the SC pin to -S.

General Information

Micro PlugMate

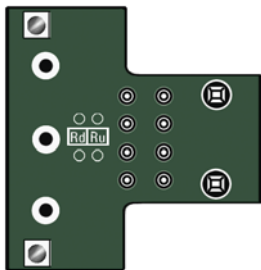

Mini/Maxi PlugMate

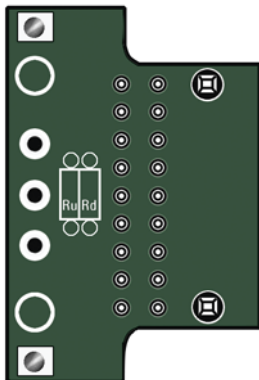

Trimming

Provisions have been made on PlugMate output connectors for adding resistors to trim the output voltage up or down. Consult the design calculator, for Rd/Ru trim resistor values, located at vicorpower.com.

Rd = Trim Down

Ru = Trim Up

Suggested Wire Gauge

Function	Wire Gauge	Application	
DC Input/Output Leads	#20	0 A - 3 A	
	#18	4 A - 6A	(PlugMate)
	#16	7 A - 10 A	
	#14	11 A - 15 A	
	#12	16 A - 25 A	
	#10	26 A - 40 A	
	#8	41 A - 65 A	
	#6	66 A - 104 A	
	#4	105 A - 160 A	

VIPAC Array Configurations

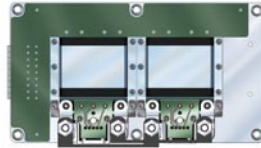
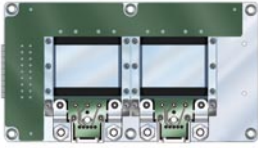

VA-A

Single or Dual Output Models
Up to 600 Watts

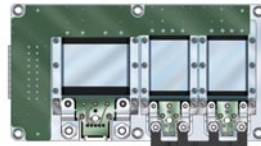
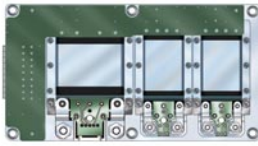

VA-B

Dual or Triple Output Models
Up to 600 Watts

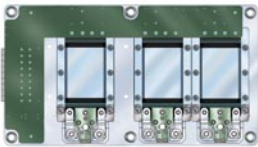

VA-C

Dual or Triple Output Models
Up to 450 Watts

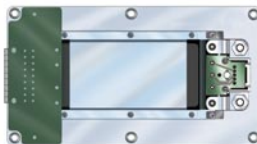

VA-D/J

Single Output
Up to 600 Watts

Current share option is available for
redundant or higher power applications.

VIPAC Array Configurations

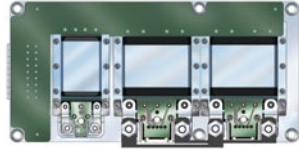

VA-E

Dual or Triple Output Models
Up to 750 Watts

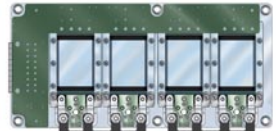
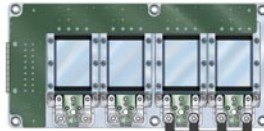
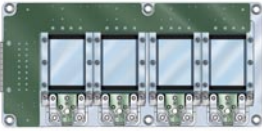

VA-F

Dual, Triple or Quad Output Models
Up to 600 Watts

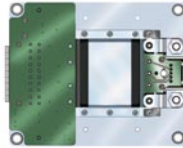

VA-G/K

Single Output
Up to 300 Watts

Current share option is available for
redundant or higher power applications.

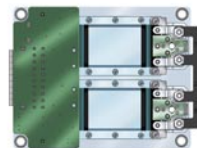
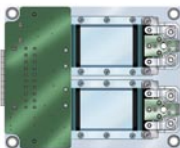

VA-H

Single or Dual Output Models
Up to 300 Watts

*Information furnished by Vicor is believed to be accurate and reliable. However, no responsibility is assumed by Vicor for its use. No license is granted by implication or otherwise under any patent or patent rights of Vicor. Vicor components are not designed to be used in applications, such as life support systems, wherein a failure or malfunction could result in injury or death. All sales are subject to Vicor's Terms and Conditions of Sale, which are available upon request. No user serviceable components, contact Vicor to arrange for repair or replacement. **Specifications are subject to change without notice.***

Visit the Vicor website at:
vicorpower.com

Vicor Corporation

Andover, MA U.S.A.
Tel: 800-927-9474
Fax: 978-475-6715

Chicago, IL
Tel: 630-769-8780
Fax: 630-769-8782

Sunnyvale, CA
Tel: 408-522-5280
Fax: 408-774-5555

Vicor France

Tel: +33 1 34 52 18 30
Fax: +33 1 34 52 28 30

Vicor Germany

Tel: +49 89 962 439 0
Fax: +49 89 962 439 39

Vicor Italy

Tel: +39 02 22 47 23 26
Fax: +39 02 22 47 31 66

Vicor U.K.

Tel: +44 1276 678222
Fax: +44 1276 681269

Vicor Japan Co., Ltd.

Tel: +81-3-5487-3880
Fax: +81-3-5487-3885

Vicor Hong Kong

Tel: +852-2956-1782
Fax: +852-2956-0782